

The newborn VH series valve island proposed by Airwork, represents the new trend in the pneumatic field, which responds to the increasing need of energy saving and reduced dimensions while maintaining suitable flow rates. It's proposed in multipolar system with D-SUB 25 pin connection or with flat cable.

Key-points:

- Small size (15mm) • Low power consumption (0.85W) • Compact and clean design • Metal components for longer life even in harsh environments • Fast response thanks to latest generation solenoids • Manual operating easily accessible • LED indicator integrated in the solenoid • Sub-base with exclusive modular system
- All packs are delivered assembled and tested.

L'îlot d'électrodistributeurs de la série VH représente une nouveauté dans le secteur de l'automatisation. Il permet une économie d'énergie et un encombrement réduit tout en maintenant des débits appropriés. C'est un système multipolaire avec une connexion à 25 broches SUB-D ou avec un câble plat. Points clés: Petite taille (15mm) • Faible consommation d'énergie (0.85W) • Conception compacte et propre • Composants métalliques pour une longue durée de vie même dans des environnements difficiles • Réponse rapide grâce aux bobines de dernière génération • Fonctionnement manuel facilement accessible • Indicateur LED intégré dans les bobines • Embase avec système modulaire exclusif • Tous les îlots sont livrés assemblés et testés

Le nuove isole di valvole serie VH proposte da Airwork, rappresentano la nuova tendenza della pneumatica moderna che risponde ad esigenze di risparmio energetico e ingombri sempre più contenuti, pur mantenendo portate di tutto rispetto.

La serie VH dispone di un sistema di connessione elettrica multipolare con presa D-SUB 25 pin o con cavo Flat.

Punti di forza:

- Dimensioni ridotte (15mm) • Basso assorbimento di corrente (0.85W) • Design compatto e pulito • Componenti in metallo per garantire lunga durata anche in ambienti difficili • Elevata velocità di risposta grazie agli elettrovalvole di ultima generazione • Azionamento manuale di facile accesso • Indicatore LED integrato nell'elettropilota • Sottobase con esclusivo sistema modulare • Tutte le isole sono consegnate montate e collaudate



TECHNICAL DATA / DONNÉES TECHNIQUES / DATI TECNICI

Fluid / Fluide / <i>Fluido</i>		Air / Air / <i>Aria</i>	
Max operating pressure / Pression max d'utilisation / <i>Pressione massima di esercizio</i>	Internal pilot / pilotage interne / <i>Pilotaggio interno</i>	5/2 / 5/2 / 5/2	1,5 ÷ 7 bar
		5/3 monostable / 5/3 monostable / 5/3 monostabile	2 ÷ 7 bar
		3/2 + 3/2	1,5 ÷ 7 bar
	Internal pilot / pilotage interne / <i>Pilotaggio interno</i>	Pressure range / Pression d'utilisation / <i>Pressione di utilizzo</i>	- 1 ÷ 7 bar
		Pilot pressure / Pression pilote / <i>Pressione pilota</i>	2,5 ÷ 7 bar
Max working temperature / Température max d'utilisation / <i>Temperatura max di esercizio</i>		-5°C / + 50°C	
Flow rate to 6 bar and Δp 1 bar / Débit à 6 bar Δp 1 bar / <i>Portata a 6 bar e Δp 1 bar</i>	5/2 monostable Ø8 / 5/2 monostable Ø8 / 5/2 monostabile Ø8		650 Nl/min
	5/2 bistable Ø8 / 5/3 bistable Ø8 / 5/3 bistabile Ø8		650 Nl/min
	5/3 CC Ø8 / 5/3 CF Ø8 / 5/3 CC Ø8		500 Nl/min
	5/3 CO Ø8 / 5/3 CO Ø8 / 5/3 CA Ø8		500 Nl/min
	5/3 CP Ø8 / 5/3 CP Ø8 / 5/3 CP Ø8		700 Nl/min
3/2 + 3/2 Ø8		550 Nl/min	
Voltage / Tension électrique / <i>Tensione elettrica</i>		24VDC, 12VDC	
Voltage tolerance / Tolérance de tension / <i>Tolleranza di tensione</i>		± 10%	
Power consumption / Consommation d'énergie / <i>Assorbimento</i>		0.85 W (DC)	
Insulation / Isolation / <i>Isolamento</i>		classe F	
Protection degree / Degré de protection / <i>Grado di protezione</i>		IP 65 (D-SUB - FLAT : IP 40)	
Valve width / Largeur de la valve / <i>Larghezza valvola</i>		15mm	
Indicators / Indicateurs / <i>Indicatori</i>		LED	
Type of connection / Type de connexion / <i>Tipo di connessione</i>		D-SUB 25 pin / Flat cable	
Max stations / Max stations / <i>Massimo numero stazioni</i>		24	
A-B port size / Taille de port A-B / <i>Taglia porta A-B</i>		Ø4 - Ø6 - Ø8	
Weight / Poids / <i>Pesi</i>	5/2 monostable Ø8 / 5/2 monostable Ø8 / 5/2 monostabile Ø8		gr 84
	5/2 bistable Ø8 / 5/3 bistable Ø8 / 5/3 bistabile Ø8		gr 94
	5/3 CC Ø8 / 5/3 CF Ø8 / 5/3 CC Ø8		gr 100
	Manifold side cover / Manifold couvercle / <i>Manifold coperchi</i>		gr 338
Base product / Produit de base / <i>Prodotti base</i>		gr 80	

DIN RAIL TYPE / VERSION DIN RAIL / VERSIONE GUIDA DIN

Solenoid A turns On the Red led
Solenoid B turns On the Green led.
Solenoid A allume la led Rouge
Solenoid B allume la led Verte.
Solenoid A accende il led Rosso
Solenoid B accende il led Verde.

Possibility to select the integrated exhaust and built-in method silencer.
Possibilité de sélectionner la méthode intégrée d'échappement et avec silencieux intégrée.
È possibile selezionare il metodo integrato di scarico e silenziatore.

The wiring is possible either vertically or horizontally.
Le câblage est possible verticalement ou horizontalement.
Il cablaggio è possibile sia in verticale sia in orizzontale.

Quick and easy system to allow the addition or the removal of valves.
Système rapide et facile pour permettre l'ajout ou le retrait des vannes.
Sistema rapido e semplice per consentire l'aggiunta e la rimozione delle valvole.

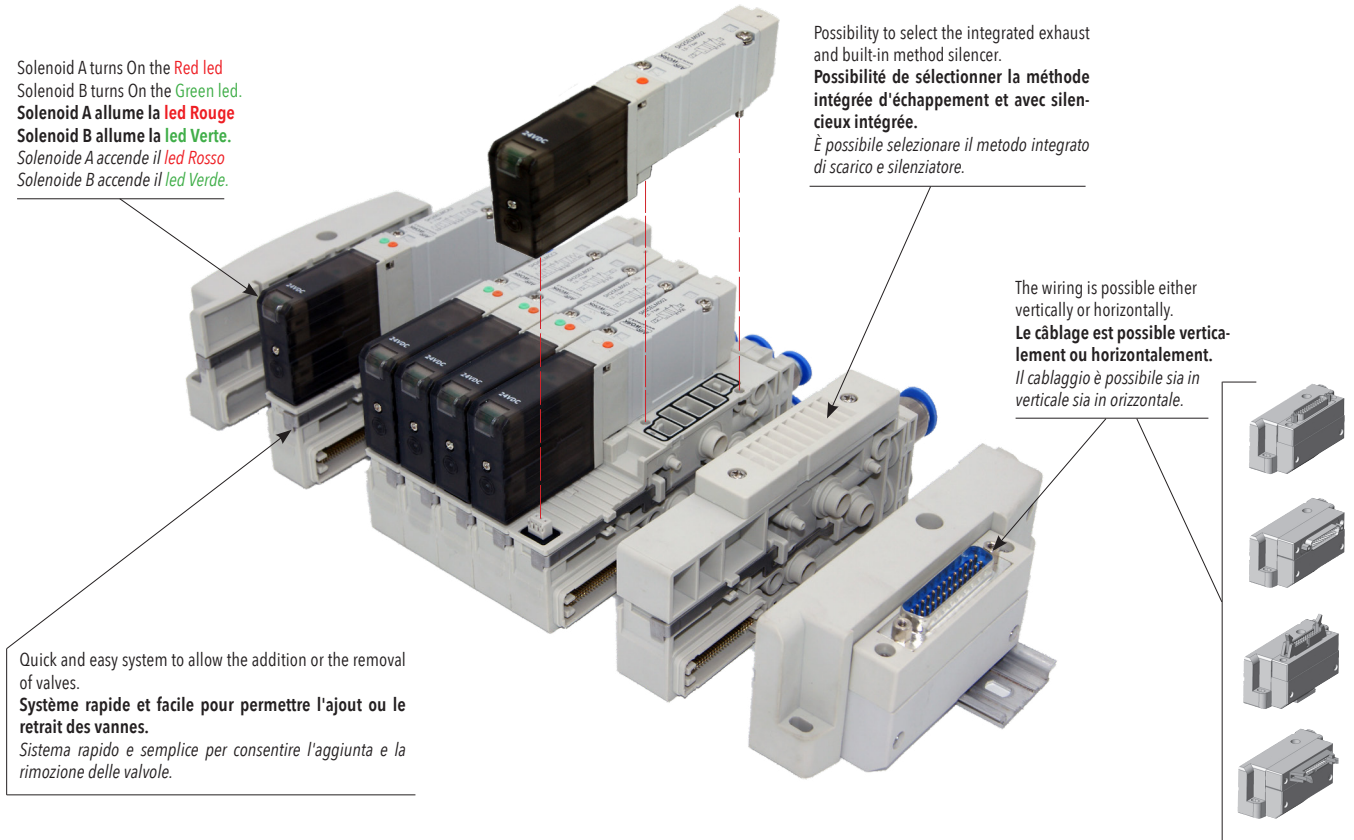

TIE ROD TYPE / VERSION AVEC TIRANTS / VERSIONE A TIRANTI

External piloting system. Application available for different pressures or vacuum control.
Système de pilotage externe. Disponible pour différentes commandes de pression ou pour le vide.
Sistema di pilotaggio esterno. Disponibile per diversi controlli di pressione o vuoto.

Manual control unlockable.
Commande manuelle non verrouillable.
Comando manuale non bloccabile.

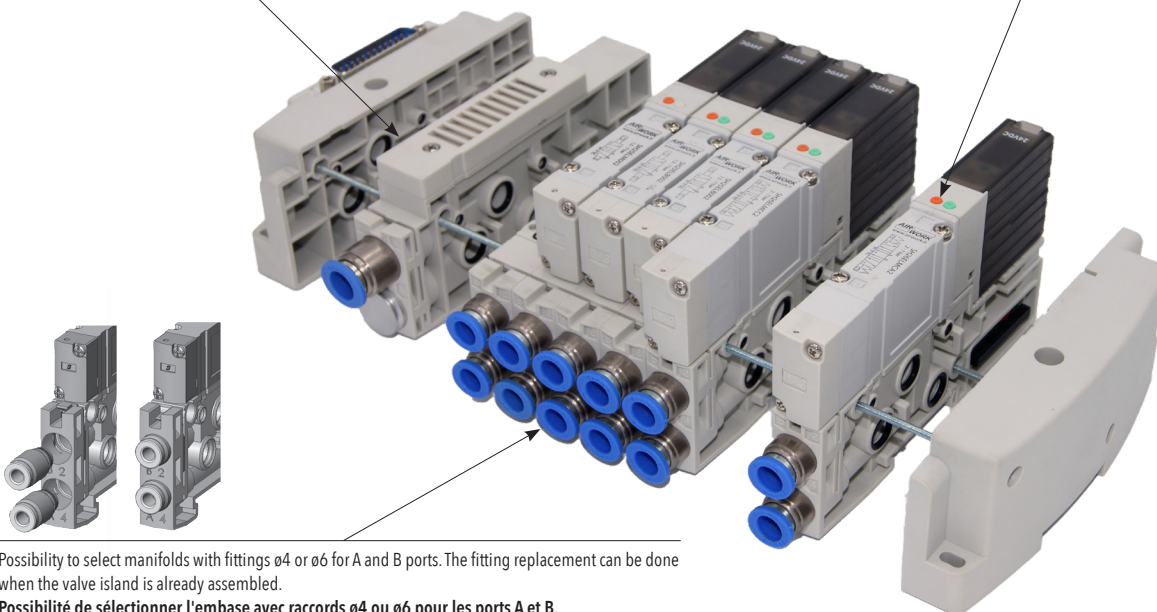

Possibility to select manifolds with fittings $\varnothing 4$ or $\varnothing 6$ for A and B ports. The fitting replacement can be done when the valve island is already assembled.
Possibilité de sélectionner l'embase avec raccords $\varnothing 4$ ou $\varnothing 6$ pour les ports A et B.
Remplacement des raccords possible si les vannes sont déjà assemblées.
È possibile utilizzare raccordi $\varnothing 4$ oppure $\varnothing 6$ per le porte A e B. La sostituzione del raccordo è possibile anche quando l'isola di valvole è già assemblata.

ASSEMBLED UNIT ORDERING CODE / CODE DE COMMANDE D'UNITÉ ASSEMBLÉE / CHIAVE DI CODIFICA UNITA' ASSEMBLATA

The following ordering code, has the purpose to give to Airwork all necessary information and specification required from the customer. Subsequently, for convenience, a univocal 9-digit short code will be generated and will be communicated to the customer at the time of order confirmation.

Le code de commande ci-dessous, a pour but de donner à Airwork toutes les informations nécessaires et les spécifications requises par le client. Par la suite, pour plus de commodité, un code court spécifique de 9 chiffres sera généré et communiqué au client au moment de la confirmation de la commande.

La chiave di codifica qui sotto riportata, ha lo scopo di fornire ad Airwork tutte le informazioni e le specifiche di cui il cliente ha bisogno. Successivamente, per comodità, verrà generato un codice breve univoco a 9 cifre che verrà comunicato al cliente al momento della conferma d'ordine.

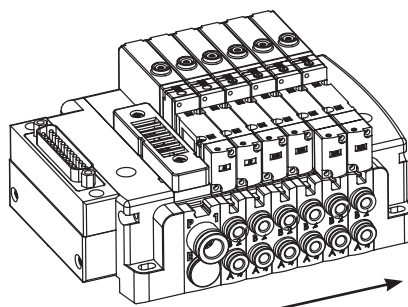

From left to right
Du gauche à droite
Da sinistra a destra

V H 2 - S O - 1 0 - I S - B - T - 1 2 - 2 4 - A B C D E F G H I J K L M N O P Q R S T U V W X Z

SHORT CODE / CODE COURT / CODICE BREVE

- A= 5/2 monostable, tube Ø4 / 5/2 monostable, tube Ø4 / 5/2 monostabile, tubo Ø4
- B= 5/2 monostable, tube Ø6 / 5/2 monostable, tube Ø6 / 5/2 monostabile, tubo Ø6
- C= 5/2 monostable, tube Ø8 / 5/2 monostable, tube Ø8 / 5/2 monostabile, tubo Ø8
- D= 5/2 bistable, tube Ø4 / 5/2 bistable, tube Ø4 / 5/2 bistabile, tubo Ø4
- E= 5/2 bistable, tube Ø6 / 5/2 bistable, tube Ø6 / 5/2 bistabile, tubo Ø6
- F= 5/2 bistable, tube Ø8 / 5/2 bistable, tube Ø8 / 5/2 bistabile, tubo Ø8
- G= 5/3 closed centers, tube Ø4 / 5/3 centres fermés, tube Ø4 / 5/3 centri chiusi, tubo Ø4
- H= 5/3 closed centers, tube Ø6 / 5/3 centres fermés, tube Ø6 / 5/3 centri chiusi, tubo Ø6
- I= 5/3 closed centers, tube Ø8 / 5/3 centres fermés, tube Ø8 / 5/3 centri chiusi, tubo Ø8
- J= 5/3 open centers, tube Ø4 / 5/3 centres ouverts, tube Ø4 / 5/3 centri aperti, tubo Ø4
- K= 5/3 open centers, tube Ø6 / 5/3 centres ouverts, tube Ø6 / 5/3 centri aperti, tubo Ø6
- L= 5/3 open centers, tube Ø8 / 5/3 centres ouverts, tube Ø8 / 5/3 centri aperti, tubo Ø8
- M= 5/3 pressure centers, tube Ø4 / 5/3 centre pression, tube Ø4 / 5/3 centri n pressione, tubo Ø4
- N= 5/3 pressure centers, tube Ø6 / 5/3 centre pression, tube Ø6 / 5/3 centri n pressione, tubo Ø6
- O= 5/3 pressure centers, tube Ø8 / 5/3 centre pression, tube Ø8 / 5/3 centri n pressione, tubo Ø8
- P= 2x3/2 NC+NC, tube Ø4 / 2x3/2 NF+NF, tube Ø4 / 2x3/2 NC+NC, tubo Ø4
- Q= 2x3/2 NC+NC, tube Ø6 / 2x3/2 NF+NF, tube Ø6 / 2x3/2 NC+NC, tubo Ø6
- R= 2x3/2 NC+NC, tube Ø8 / 2x3/2 NF+NF, tube Ø8 / 2x3/2 NC+NC, tubo Ø8
- S= 2x3/2 NO+NO, tube Ø4 / 2x3/2 NO+NO, tube Ø4 / 2x3/2 NA+NA, tubo Ø4
- T= 2x3/2 NO+NO, tube Ø6 / 2x3/2 NO+NO, tube Ø6 / 2x3/2 NA+NA, tubo Ø6
- U= 2x3/2 NO+NO, tube Ø8 / 2x3/2 NO+NO, tube Ø8 / 2x3/2 NA+NA, tubo Ø8
- V= 2x3/2 NC+NO, tube Ø4 / 2x3/2 NF+NO, tube Ø4 / 2x3/2 NC+NA, tubo Ø4
- W= 2x3/2 NC+NO, tube Ø6 / 2x3/2 NF+NO, tube Ø6 / 2x3/2 NC+NA, tubo Ø6
- X= 2x3/2 NC+NO, tube Ø8 / 2x3/2 NF+NO, tube Ø8 / 2x3/2 NC+NA, tubo Ø8
- Z= CLOSING PLATE / PLAQUE DE FERMETURE / PIATRINA DI CHIUSURA

POSITIONS NUMBER / NUMÉRO DE POSITIONS / NUMERO POSIZIONI

- 01= 1 position / 1 position / 1 posizione
- +
- 24= 24 positions / 24 positions / 24 posizioni

VOLTAGE / TENSION / TENSIONE

- 12= 12 VDC
- 24= 24 VDC

ASSEMBLY TYPE / TYPE D'ASSEMBLAGE / TIPO DI ASSEMBLAGGIO

- T= With tie rod / Avec tirants / Con tiranti
- D= With DIN rail / Avec rail DIN / Con guida DIN
- N= Nothing (max 4 pos.) / Rien (max 4 pos.) / Niente (max 4 pos.)

TERMINAL / TERMINAL / TERMINALI

SH	D-SUB horizontal D-SUB horizontal D-SUB orizzontale	
SV	D-SUB vertical D-SUB vertical D-SUB verticale	
FH	FLAT horizontal FLAT horizontal FLAT orizzontale	
FV	FLAT vertical FLAT vertical FLAT verticale	

SUPPLY-EXHAUST TYPE / TYPE D'ALIMENTATION-
ECHAPPEMENT / TIPO DI ALIMENTAZIONE-SCARICHI

IW	Internal without silencer Interne sans silencieux Interno senza silenziatore	
IS	Internal with silencer Interne avec silencieux Interno con silenziatore	
EW	External without silencer Externe sans silencieux Esterno senza silenziatore	
ES	External with silencer Externe avec silencieux Esterno con silenziatore	

SUPPLY-EXHAUST POSITIONS / POSITIONS D'ALIMENTATION-
ECHAPPEMENT / POSIZIONE ALIMENTAZIONE-SCARICHI

L	Left Gauche Sinistra	
R	Right Droite Destra	
B	Both Tous le deux Entrambe	

SOLENOID VALVE MODULE / **MODULE ELECTROVANNE** / **MODULO ELETTROVALVOLA**

SH25ELM00106

- **A - B PORT SIZE / TAILLE DU PORTS A - B / TAGLIA PORTE A - B**
04 = Ø4 mm
06 = Ø6 mm
08 = Ø8 mm
- **VOLTAGE / TENSION / TENSIONE**
1 = 12 VDC
2 = 24 VDC
- **OPERATION / OPERATION / FUNZIONAMENTO**
00 = 5/2
CC = CLOSED CENTERS / **CENTRES FERMÉS** / **CENTRI CHIUSI**
CA = OPEN CENTERS / **CENTRES OUVERTS** / **CENTRI APERTI**
CP = PRESSURIZED CENTERS / **CENTRES EN PRESSION** / **CENTRI IN PRESSIONE**
2C = 3/2 + 3/2 NC-NC
2A = 3/2 + 3/2 NA-NA
2X = 3/2 + 3/2 NC-NA
- **FUNCTION / FONCTION / FUNZIONAMENTO**
M = Monostable / **Monostable** / *Monostabile*
B = Bistable / **Bistable** / *Bistabile*
- **PILOT TYPE / TYPE DE PILOTE / TIPO DI PILOTAGGIO**
EL = Internal / **Interne** / *Interno*
EA = External / **Externe** / *Esterno*
- **PORTS / PORTS / PORTE**
3 = 3/2
5 = 5/2
6 = 5/3





SH2M08 = CLOSING PLATE MONOSTABLE / **PLAQUE DE FERMETURE MONOSTABLE** / *PIASTRINA DI CHIUSURA MONOSTABILE*
SH2B08 = CLOSING PLATE BISTABLE / **PLAQUE DE FERMETURE BISTABLE** / *PIASTRINA DI CHIUSURA BISTABILE*

SUPPLY-EXHAUST MODULE / **MODULE ALIMENTATION-ECHAPPEMENT** / **MODULO ALIMENTAZIONE-SCARICHI**

AH2IW

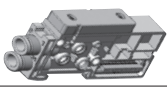
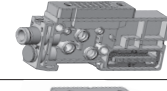
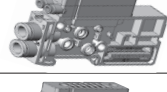
→ **PILOT TYPE / TYPE DE PILOTE / TIPO DI PILOTAGGIO**





IW	Internal without silencer Interne sans silencieux <i>Interno senza silenziatore</i>	
IS	Internal with silencer Interne avec silencieux <i>Interno con silenziatore</i>	
EW	External without silencer Externe sans silencieux <i>Esterno senza silenziatore</i>	
ES	External with silencer Externe avec silencieux <i>Esterno con silenziatore</i>	



TERMINAL / **TERMINAL** / **TERMINALI**

EH2SH

→ **CONNECTION TYPE / TYPE DE CONNEXION / TIPO DI CONNESSIONE**

SH	D-SUB horizontal D-SUB horizontal <i>D-SUB orizzontale</i>	
SV	D-SUB vertical D-SUB vertical <i>D-SUB verticale</i>	
FH	FLAT horizontal FLAT horizontal <i>FLAT orizzontale</i>	
FV	FLAT vertical FLAT vertical <i>FLAT verticale</i>	

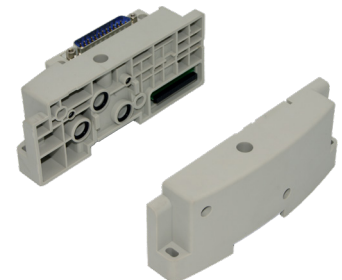

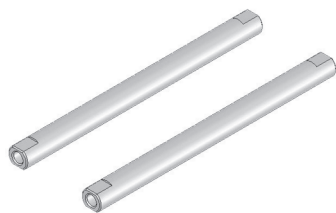

TIE-ROD
TIRANTS
TIRANTI

CODE

From / A partir / A partire

TH205 5 manifolds + 1 module sup/exh / 5 collecteurs + 1 module sup/exh.
5 stazioni + 1 modulo sup/exh.

To / Jusqu'à / Fino a

TH224 24 manifolds + 1 module sup/exh / 24 collecteurs + 1 module sup/exh.
24 stazioni + 1 modulo sup/exh.



TIE-ROD FOR SUP/EXH MODULES ADDITIONAL
TIRANTS POUR MODULES SUP/EXH ADDITIONNEL

TIRANTE PER MODULI SUP/EXH AGGIUNTIVI
CODE

TH2001 1 Module / Module / Modulo

1 for each extra module (maximum 3 modules).

1 pour chaque module supplémentaire (maximum 3 modules).

1 per ogni extra modulo (massimo 3 moduli).

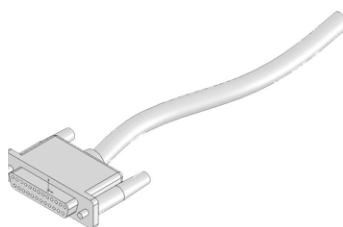

D-SUB CONNECTOR 25 PIN
CONNECTEUR D-SUB À 25 PIN
CONNETTORE D-SUB 25 PIN

CODE

VX0062 1.5 mt

VX0063 3 mt

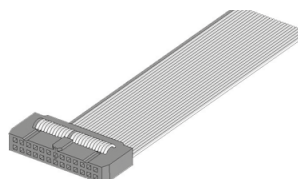

FLAT CABLE CONNECTOR
CONNECTEUR DE CÂBLE PLAT
CONNETTORE FLAT

CODE

VX0064 1.5 mt

VX0065 3 mt

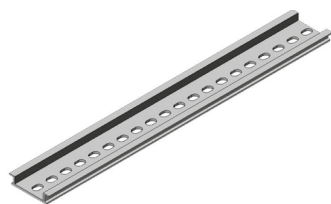

DIN RAIL
RAIL DIN
BARRA DIN

CODE

RH206 2 - 6 stations

RH210 7 - 10 stations

RH215 11 - 15 stations

RH220 16 - 20 stations

RH224 21 - 24 stations

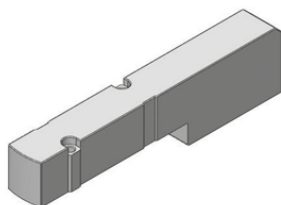

BLANKING PLATE
PLAQUE D'OBTURATION
PIASTRA DI CHIUSURA

CODE

BH200



DIAPHRAGM SEAL
JOINT DIAPHRAGME
GUARNIZIONE DIAFRAMMA

CODE

DH200

MOUNTING SYSTEMS / SYSTÈMES DE MONTAGE / SISTEMI DI FISSAGGIO

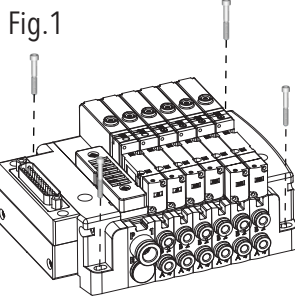

With through screws.
Avec vis traversantes.
Con viti passanti.

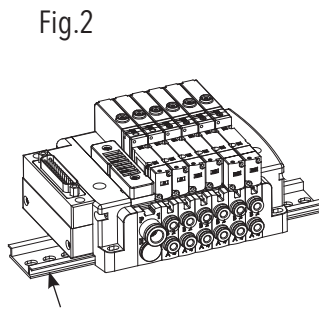

On omega bar DIN.
Sur rail oméga DIN.
Su barra oméga DIN.

The VH valve island can be mounted with through screws (fig. 1) or an omega DIN rail (fig.2).

L'îlot des électrovannes VH peut être monté avec des vis traversantes (fig.1) ou sur rail oméga DIN (fig.2).

L'isola di elettrovalvole VH può essere montata sia tramite viti (fig. 1) oppure tramite una barra oméga DIN (fig.2).

ASSEMBLY-DISASSEMBLY OF TIE ROD TYPE / MONTAGE-DÉMONTAGE DU VERSION AVEC TIRANTS / MONTAGGIO-SMONTAGGIO DELLA VERSIONE A TIRANTI

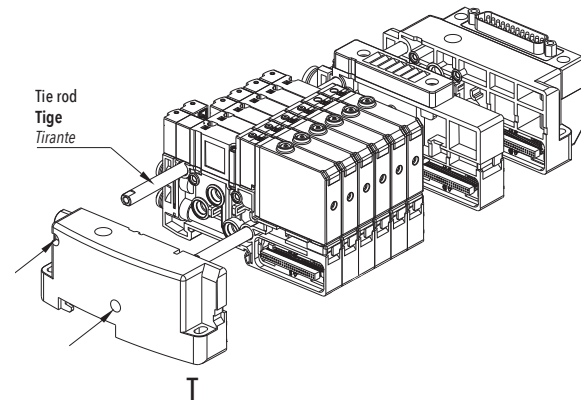

Use this assembling solution when the VH valves island is installed in severe vibration conditions or when a huge amount of valves is installed. In case of base disassembly, start disassembling the valves block from the T-Side, after removing the 2 screws mounted onto it.

Utilisez cette solution d'assemblage lorsque l'îlot de vannes VH est installé dans des conditions de vibrations sévères ou lorsqu'une connexion multiple est utilisée. En cas de démontage de la base, commencez à désassembler le bloc de vannes du côté T, après avoir retiré les 2 vis qui le lie.

Utilizzare questo sistema di montaggio quando l'isola di valvole VH è installata in condizioni di forti vibrazioni o quando viene utilizzato un sistema multi-connessione. Nel caso sia necessario smontare l'isola, cominciare dal lato T, rimuovendo le 2 viti che sono montate.

VALVES ADDING/REMOVAL / AJOUT-ENLÈVEMENT DES VANNES / AGGIUNTA-RIMOZIONE DELLE VALVOLE

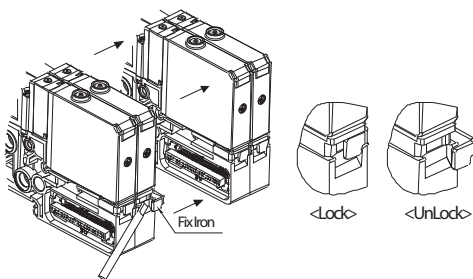

To add/remove a valve, gently UNLOCK the bracket through the usage of a flat screwdriver (or similar tool). It's not necessary to apply an excessive force that could damage the the component. Prior to add a new valve, or reconnect existing ones, please be sure that o-rings and gaskets are placed in the correct position, as well as air passages and wiring connectors.

The valve block has to be assembled or disassembled only if mounted onto a DIN rail or by using a tie-rods system. If other circumstances, the valve block has to be assembled or disassembled while laying on a flat surface. To prevent damages or wiring connection failures, check the assembly status additionally. Once everything is done, pull the bracket until it's in the LOCK position.

Pour ajouter/enlever une vanne, déverrouillez doucement le support en utilisant un tournevis plat jusqu'à la position UNLOCK (ou en utilisant un outil similaire). Il n'est pas nécessaire d'appliquer une force excessive qui pourrait endommager le composant.

Avant d'ajouter une nouvelle vanne ou de reconnecter des vannes existantes, veuillez vous assurer que les joints toriques et les autres joints d'étanchéité sont placés dans la bonne position, ainsi que les arrivées d'air et les connecteurs de câblage.

Le bloc de vannes ne doit être assemblé ou démonté que s'il est monté sur un rail DIN ou en utilisant un système de tirants. Dans d'autres circonstances, le bloc de vannes doit être assemblé ou démonté tout en étant posé sur une surface plane.

Pour éviter des dommages ou des pannes de connexion de câblage, vérifiez en plus l'état de l'assemblage. Une fois que tout est terminé, tirez le support jusqu'à ce qu'il soit en position de verrouillage LOCK.

Per aggiungere/rimuovere una valvola, spostare delicatamente la staffa di chiusura fino alla posizione di sblocco (UNLOCK) attraverso l'uso di un cacciavite piatto (o utensile simile). Non è necessario applicare una forza eccessiva che potrebbe danneggiare la base.

Prima di aggiungere una nuova valvola o ricollegare quelle esistenti, assicurarsi che gli o-ring e le guarnizioni siano posizionati nella sede corretta, nonché verificare i passaggi dell'aria e le connessioni elettriche. Il blocco valvole deve essere montato o smontato solo se installato su una guida DIN o se si sta usando un sistema a tiranti. In altre circostanze, il blocco valvole deve essere assemblato o smontato solo se appoggiato su una superficie piana. Per evitare danni o errori di connessione del cablaggio, controllare ulteriormente lo stato dell'isola di valvole. Una volta terminato, spostare la staffa finché non si trova nella posizione di chiusura (LOCK).

VALVE-MANIFOLD ASSEMBLING / ASSEMBLAGE DES VANNES SUR EMBASES / ASSEMBLAGGIO DELLE VALVOLE SULLE SOTTOBASI

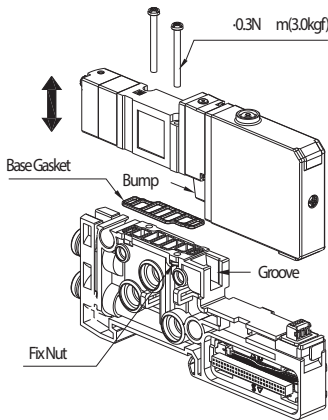

Before starting the valve's assembling onto the manifold, check the presence of the base gasket into the correct position (on the manifold).

Valve's bump and manifold groove must be aligned. Only if bump and groove are aligned, power supply connector and mount screws locations are coincident.

Insert valve's bump into base's groove in advance during valve assembly, then assemble mounting screws on the base using a proper torque.

Power connector is automatically connected by screw assembly.

Avant de commencer l'assemblage de la vanne sur l'embase, vérifiez la présence du joint de base dans la position correcte (sur le collecteur).

La butée (bump) de la vanne et la gorge (groove) du collecteur doivent être alignées. Ce n'est que si les bosses et les gorges sont alignées que l'emplacement du connecteur d'alimentation et des vis de montage coïncident. Insérez la butée de la vanne dans la gorge de la base à l'avance pendant l'assemblage de la vanne, puis assemblez les vis de montage sur la base en utilisant un couple approprié.

Le connecteur d'alimentation est automatiquement connecté par vis.

Prima di cominciare il montaggio della valvola sulla sottobase, assicurarsi della presenza della guarnizione sagomata nella posizione corretta (sulla sottobase).

Il perno (bump) sul corpo della valvola e la sede (groove) della sottobase, devono essere allineate. Solo se allineate, il connettore dell'alimentazione e gli interassi di fissaggio delle viti saranno coincidenti.

Inserire il perno della valvola nella sede della sottobase prima di cominciare l'assemblaggio completo, successivamente avvitare le viti utilizzando una forza adeguata.

L'alimentazione si connette in automatico mentre vengono fissate le viti.

FITTING REPLACEMENT METHOD / SYSTÈME POUR CHANGER LES RACCORDS / SISTEMA PER SOSTITUIRE I RACCORDI

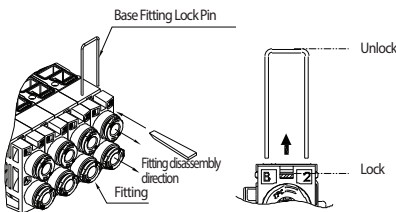

Lift the base fitting lock pin with a flat tool (like flat-head screwdriver) without applying excessive force by using a leverage effect till reach the disassemble status. After having removed the lock pin, gradually increase the force on fittings to extract them into forward direction.

Soulevez la languette de verrouillage de la base avec un outil plat (comme un tournevis à tête plate) - effet de levier - sans appliquer de force excessive jusqu'à permettre le démontage. Après avoir retiré la languette de verrouillage, basculez légèrement vers l'avant les raccords afin de les extraire.

Sollevarre il perno di blocco del raccordo di base con un utensile piatto (es. un cacciavite a testa piatta) senza applicare una forza eccessiva e usando l'effetto leva fino al raggiungimento dello stato di smontaggio.

Dopo aver rimosso il perno di blocco, aumentare gradualmente la forza sui raccordi per estrarli secondo il loro asse.

DIN-RAILTYPE MOUNTING / SYSTÈME DE MONTAGE AVEC LE RAIL DIN / SISTEMA DI MONTAGGIO CON GUIDA DIN

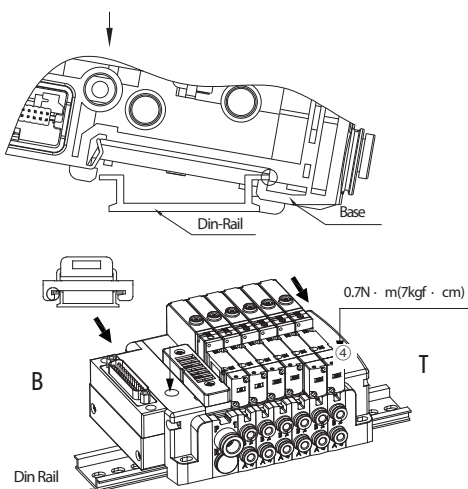

Use the DIN rail stopper (metal) mounted onto T and B-side covers to fix the valves island on the DIN rail.

Since the DIN rail stopper is possibly assembled under unstable conditions as it is shown in the figure, please connect both screws while pulling the valve's cover into the arrow direction.

Utilisez la butée du rail DIN (métallique) montée sur les couvercles des côtés T et B pour fixer l'îlot de vannes sur le rail DIN.

Comme le bouchon de rail DIN est éventuellement assemblé dans des conditions instables, voir la figure ci-contre, veuillez brancher les deux vis tout en tirant le couvercle de la vanne dans le sens de la flèche.

Utilizzare i fermi per la guida DIN montati sulle testate B e T per fissare l'isola di valvole sulla guida.

Siccome i fermi possono essere fissati anche in condizioni instabili, come mostrato in figura, stringere le viti spingendo l'isola di valvole nella direzione indicata dalla freccia.

- D-SUB CONNECTOR / **CONNECTEUR D-SUB** / CONNETTORE D-SUB

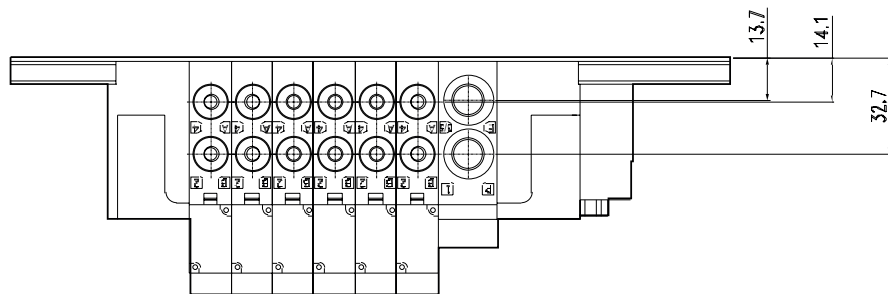
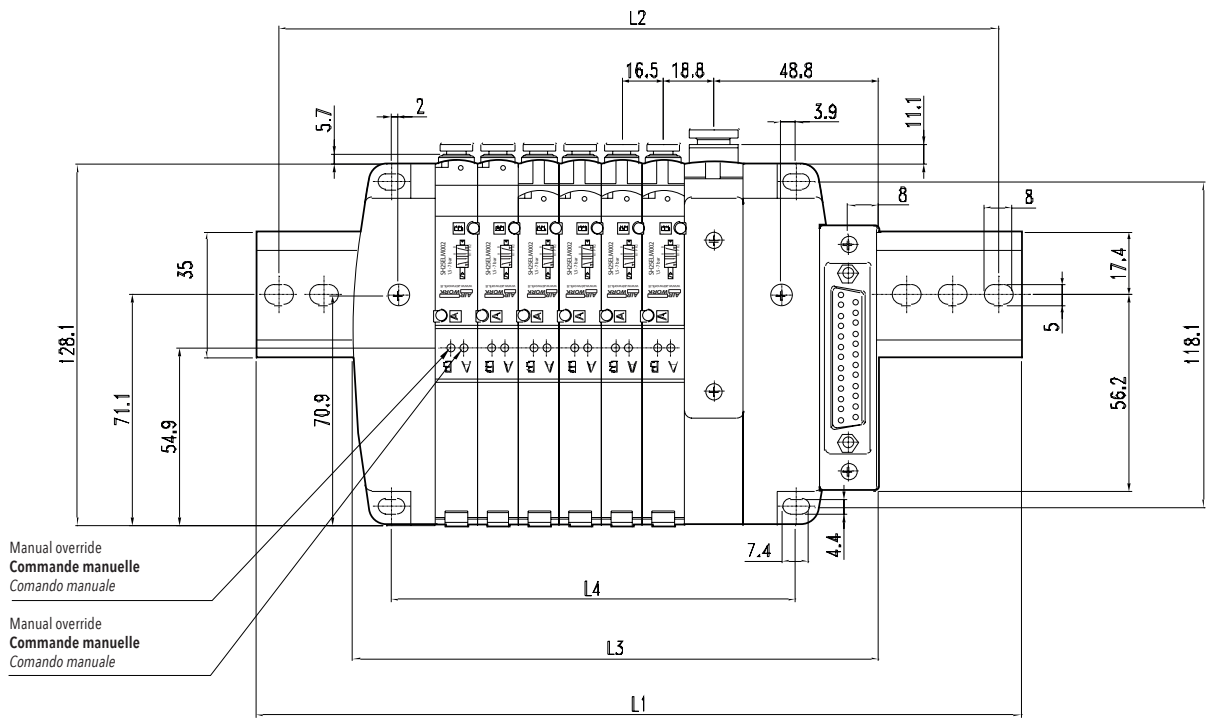
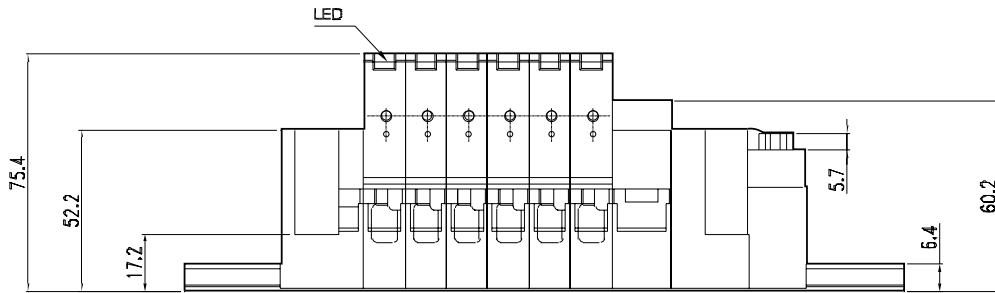

dim \ pos	2	3	4	5	6	7	8	9	10	11	12	13	14	15	16	17	18	19	20	21	22	23	24
L1	250				300				400				500				587						
L2	237.5				287.5				387.5				487.8				574.5						
L3	117.7	134.2	150.7	167.2	183.7	200.2	216.7	233.2	249.7	287.2	303.7	320.2	336.7	353.2	369.7	386.2	402.7	419.2	435.7	452.2	468.7	485.2	501.7
L4	81	97.5	114	130.5	147	163.5	180	196.5	213	250.5	267	283.5	300	316.5	333	349.5	366	382.5	399	415.5	432	448.5	465

- D-SUB CONNECTOR / **CONNECTEUR D-SUB** / CONNETTORE D-SUB
- BUILT-IN SILENCER / **SILENCIEUX INTÉGRÉ** / SILENZIATORE INTEGRATO

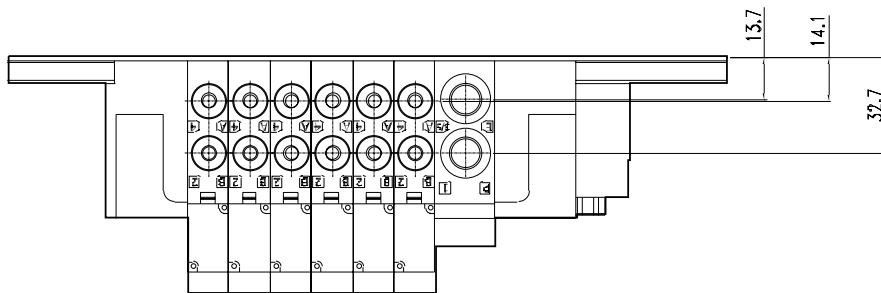
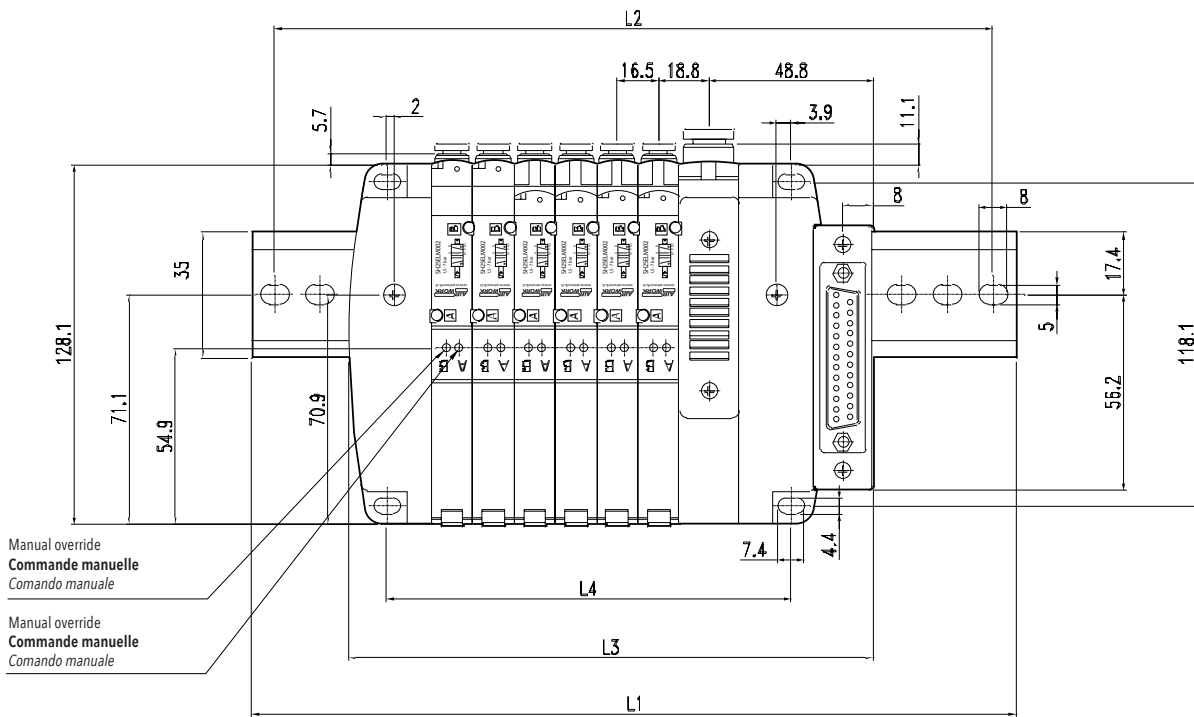
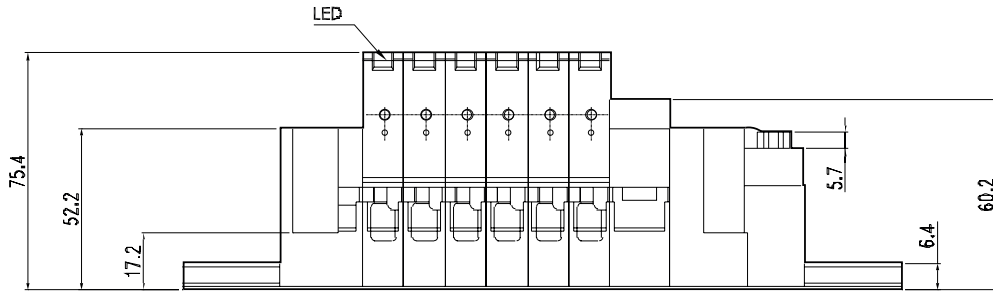

dim \ pos	2	3	4	5	6	7	8	9	10	11	12	13	14	15	16	17	18	19	20	21	22	23	24	
L1	250					300					400					500					587			
L2	237.5					287.5					387.5					487.8					574.5			
L3	117.7	134.2	150.7	167.2	183.7	200.2	216.7	233.2	249.7	287.2	303.7	320.2	336.7	353.2	369.7	386.2	402.7	419.2	435.7	452.2	468.7	485.2	501.7	
L4	81	97.5	114	130.5	147	163.5	180	196.5	213	250.5	267	283.5	300	316.5	333	349.5	366	382.5	399	415.5	432	448.5	465	

- D-SUB CONNECTOR / **CONNECTEUR D-SUB** / CONNETTORE D-SUB
- SEPARATE AIR SUPPLY / **ALIMENTATION SÉPARÉE** / ALIMENTAZIONE SEPARATA

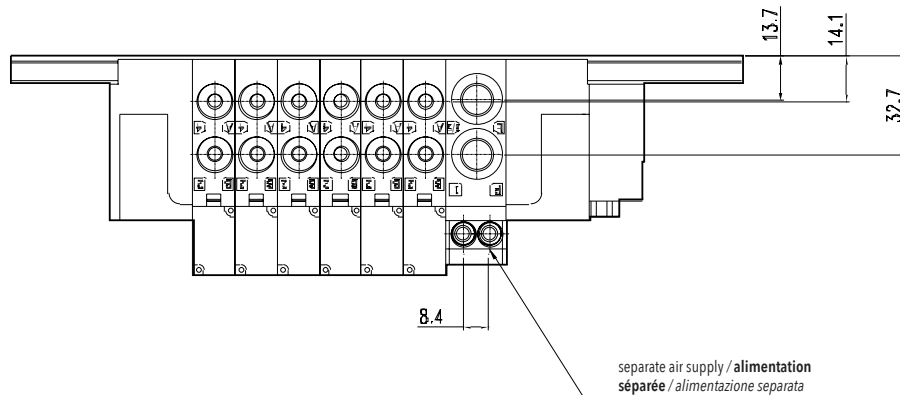
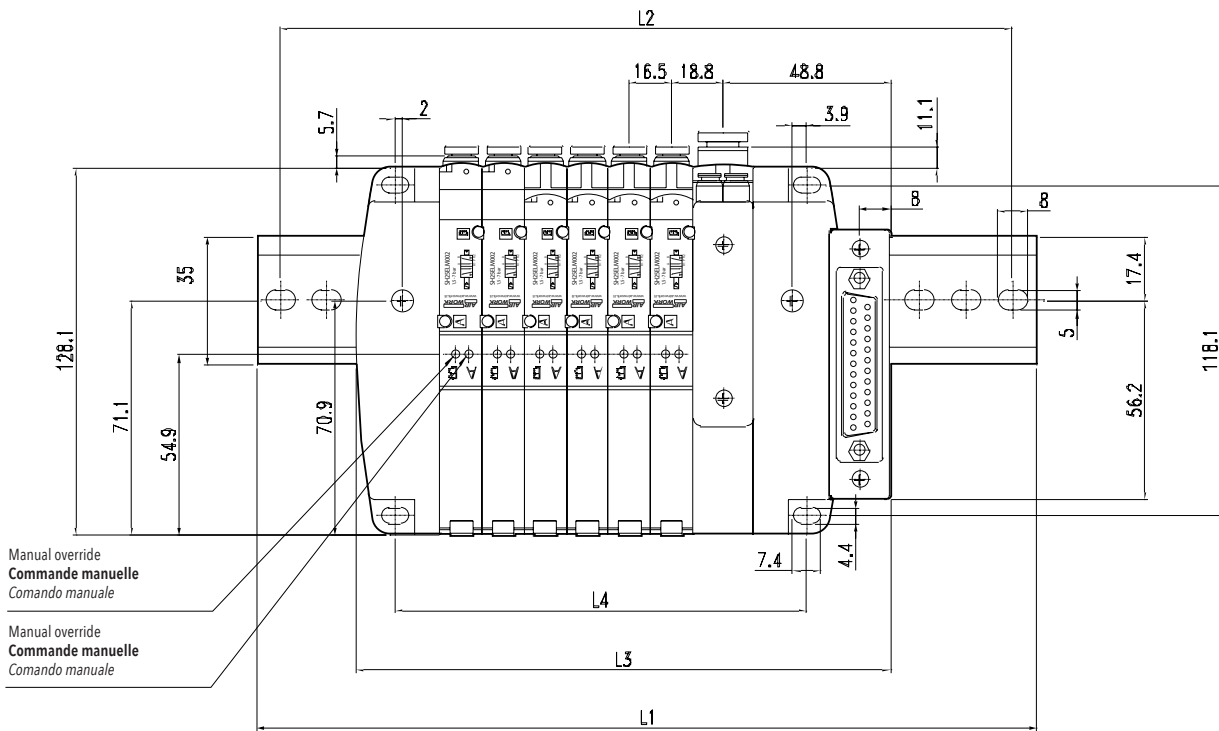
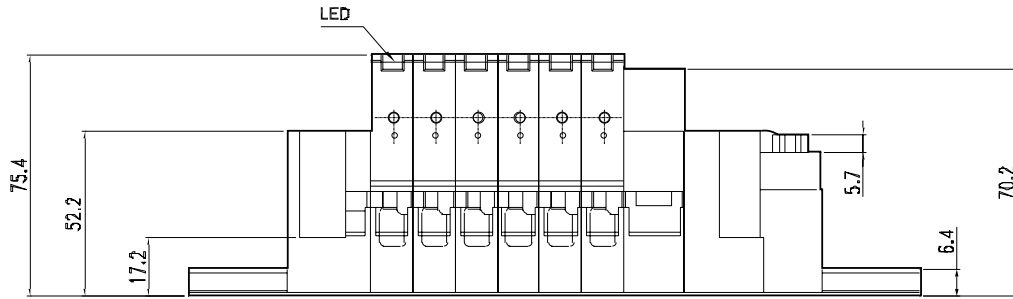

dim \ pos	2	3	4	5	6	7	8	9	10	11	12	13	14	15	16	17	18	19	20	21	22	23	24
L1	250				300				400				500				587						
L2	237.5				287.5				387.5				487.8				574.5						
L3	117.7	134.2	150.7	167.2	183.7	200.2	216.7	233.2	249.7	287.2	303.7	320.2	336.7	353.2	369.7	386.2	402.7	419.2	435.7	452.2	468.7	485.2	501.7
L4	81	97.5	114	130.5	147	163.5	180	196.5	213	250.5	267	283.5	300	316.5	333	349.5	366	382.5	399	415.5	432	448.5	465

- D-SUB CONNECTOR / **CONNECTEUR D-SUB** / CONNETTORE D-SUB
- SEPARATE AIR SUPPLY / **ALIMENTATION SÉPARÉE** / ALIMENTAZIONE SEPARATA
- BUILT-IN SILENCER / **SILENCIEUX INTÉGRÉ** / SILENZIATORE INTEGRATO

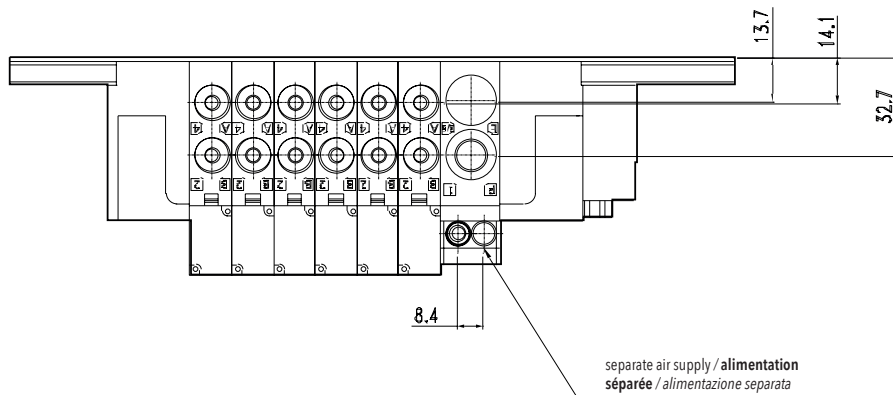
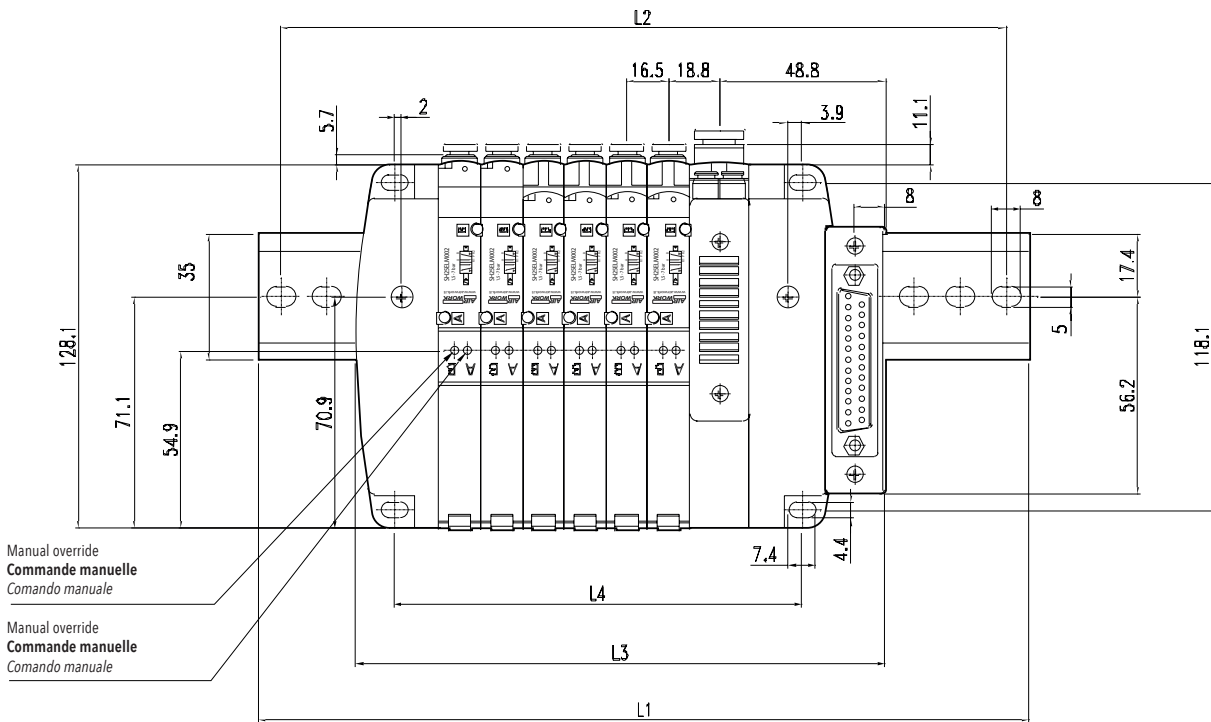
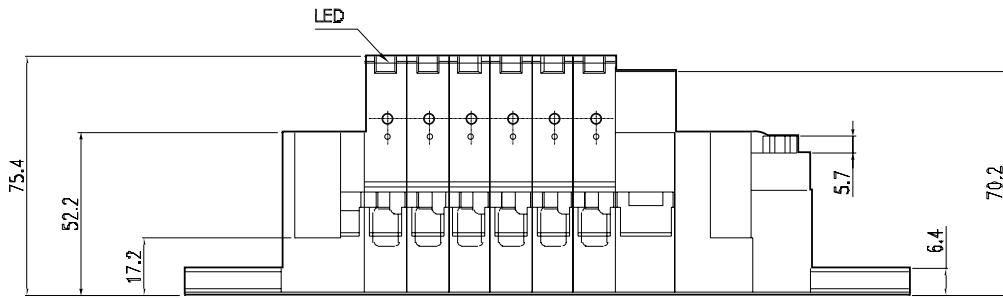

dim \ pos	2	3	4	5	6	7	8	9	10	11	12	13	14	15	16	17	18	19	20	21	22	23	24
L1			250					300				400					500					587	
L2			237.5					287.5				387.5					487.8					574.5	
L3	117.7	134.2	150.7	167.2	183.7	200.2	216.7	233.2	249.7	287.2	303.7	320.2	336.7	353.2	369.7	386.2	402.7	419.2	435.7	452.2	468.7	485.2	501.7
L4	81	97.5	114	130.5	147	163.5	180	196.5	213	250.5	267	283.5	300	316.5	333	349.5	366	382.5	399	415.5	432	448.5	465

- FLAT CONNECTOR / CONNECTEUR FLAT / CONNETTORE FLAT

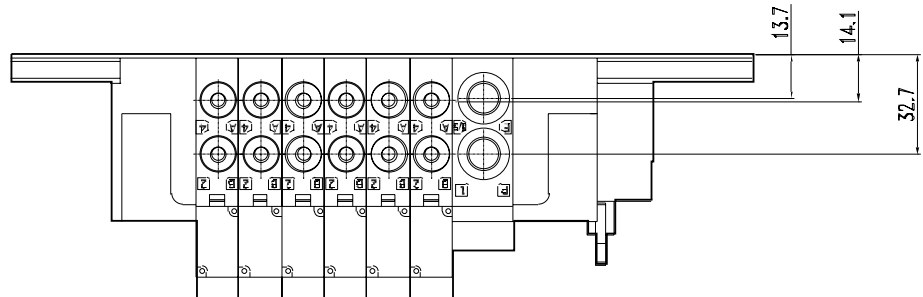
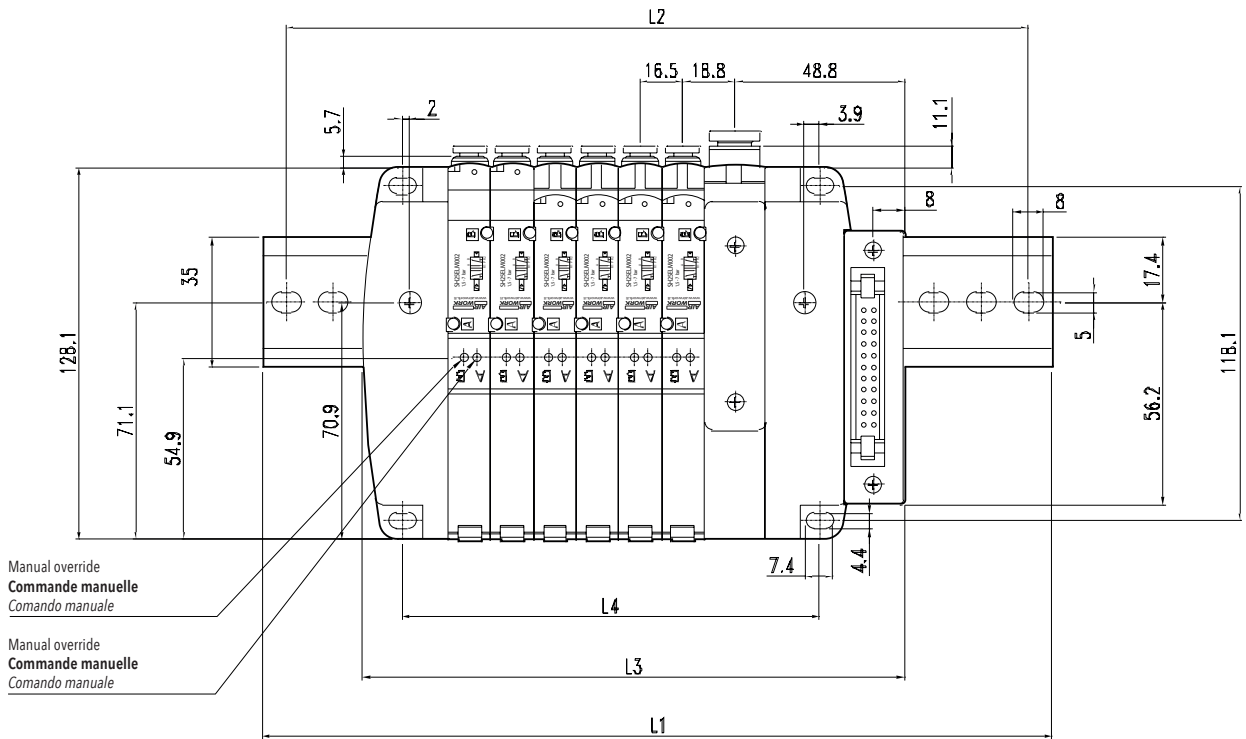
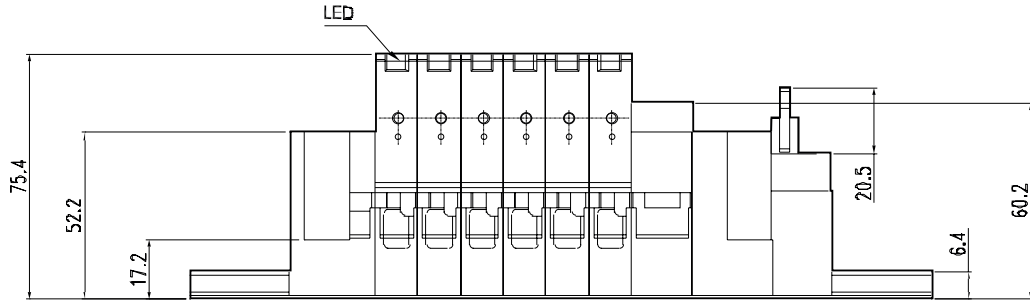

dim \ pos	2	3	4	5	6	7	8	9	10	11	12	13	14	15	16	17	18	19	20	21	22	23	24
L1	250				300				400				500				587						
L2	237.5				287.5				387.5				487.8				574.5						
L3	117.7	134.2	150.7	167.2	183.7	200.2	216.7	233.2	249.7	287.2	303.7	320.2	336.7	353.2	369.7	386.2	402.7	419.2	435.7	452.2	468.7	485.2	501.7
L4	81	97.5	114	130.5	147	163.5	180	196.5	213	250.5	267	283.5	300	316.5	333	349.5	366	382.5	399	415.5	432	448.5	465

- FLAT CONNECTOR / **CONNECTEUR FLAT** / CONNETTORE FLAT
- BUILT-IN SILENCER / **SILENCIEUX INTÉGRÉ** / SILENZIATORE INTEGRATO

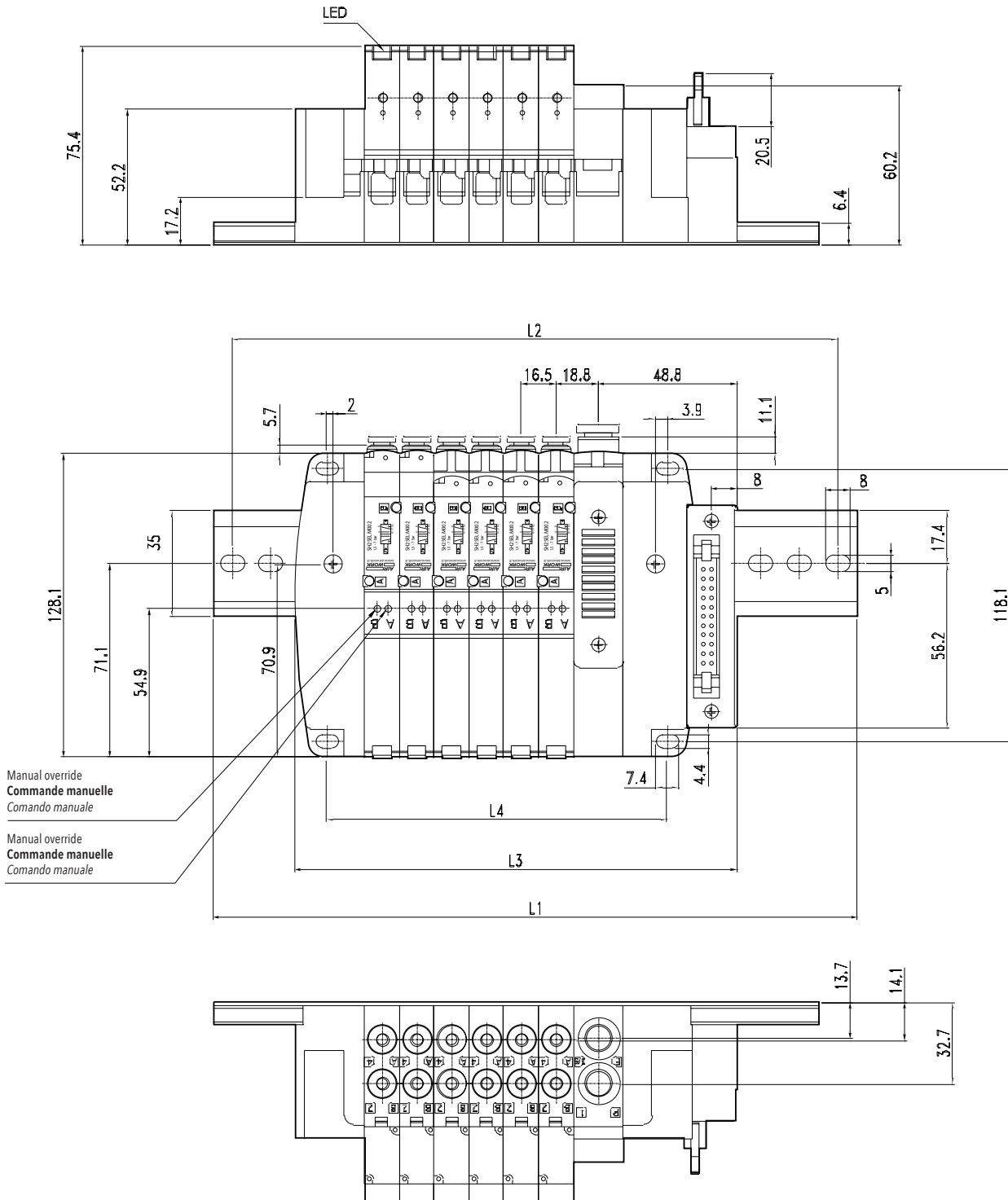

dim \ pos	2	3	4	5	6	7	8	9	10	11	12	13	14	15	16	17	18	19	20	21	22	23	24
L1			250					300				400					500					587	
L2			237.5					287.5				387.5					487.8					574.5	
L3	117.7	134.2	150.7	167.2	183.7	200.2	216.7	233.2	249.7	287.2	303.7	320.2	336.7	353.2	369.7	386.2	402.7	419.2	435.7	452.2	468.7	485.2	501.7
L4	81	97.5	114	130.5	147	163.5	180	196.5	213	250.5	267	283.5	300	316.5	333	349.5	366	382.5	399	415.5	432	448.5	465

- FLAT CONNECTOR / **CONNECTEUR FLAT** / CONNETTORE FLAT
- SEPARATE AIR SUPPLY / **ALIMENTATION SÉPARÉE** / ALIMENTAZIONE SEPARATA

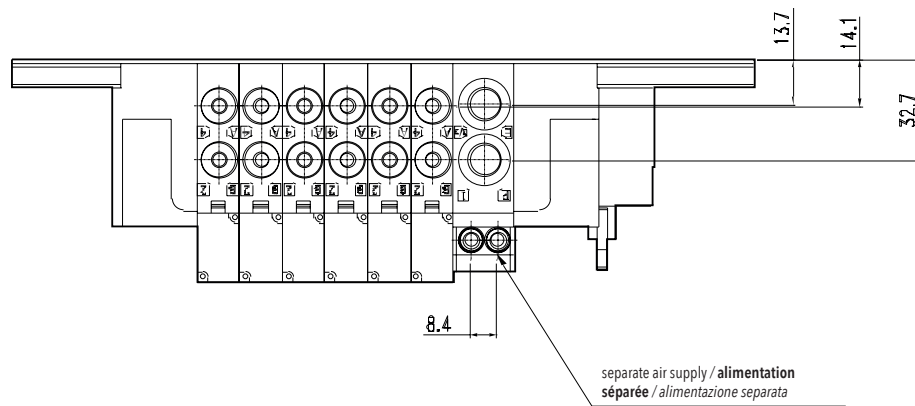
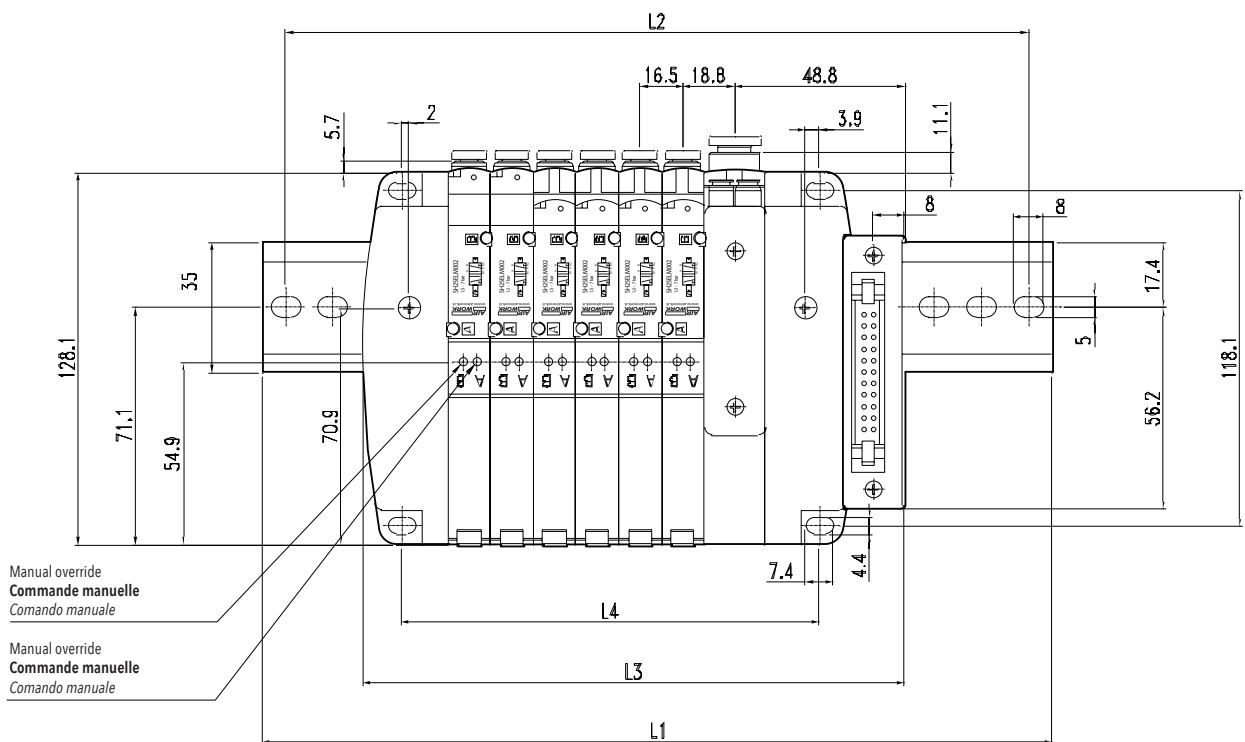
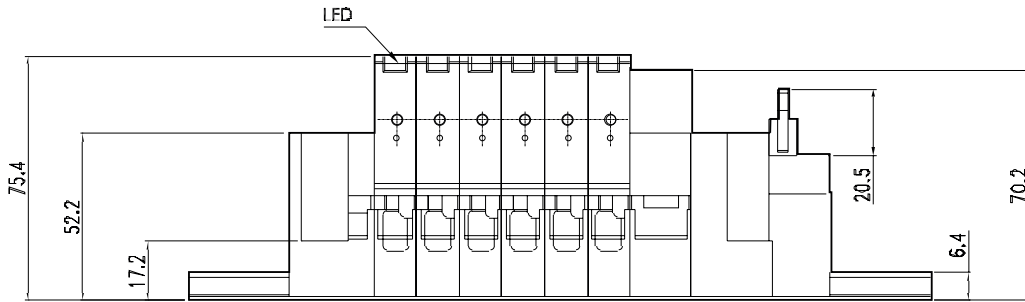

dim \ pos	2	3	4	5	6	7	8	9	10	11	12	13	14	15	16	17	18	19	20	21	22	23	24
L1	250				300				400				500				587						
L2	237.5				287.5				387.5				487.8				574.5						
L3	117.7	134.2	150.7	167.2	183.7	200.2	216.7	233.2	249.7	287.2	303.7	320.2	336.7	353.2	369.7	386.2	402.7	419.2	435.7	452.2	468.7	485.2	501.7
L4	81	97.5	114	130.5	147	163.5	180	196.5	213	250.5	267	283.5	300	316.5	333	349.5	366	382.5	399	415.5	432	448.5	465

- FLAT CONNECTOR / **CONNECTEUR FLAT** / **CONNETTORE FLAT**
- SEPARATE AIR SUPPLY / **ALIMENTATION SÉPARÉE** / **ALIMENTAZIONE SEPARATA**
- BUILT-IN SILENCER / **SILENCIEUX INTÉGRÉ** / **SILENZIATORE INTEGRATO**

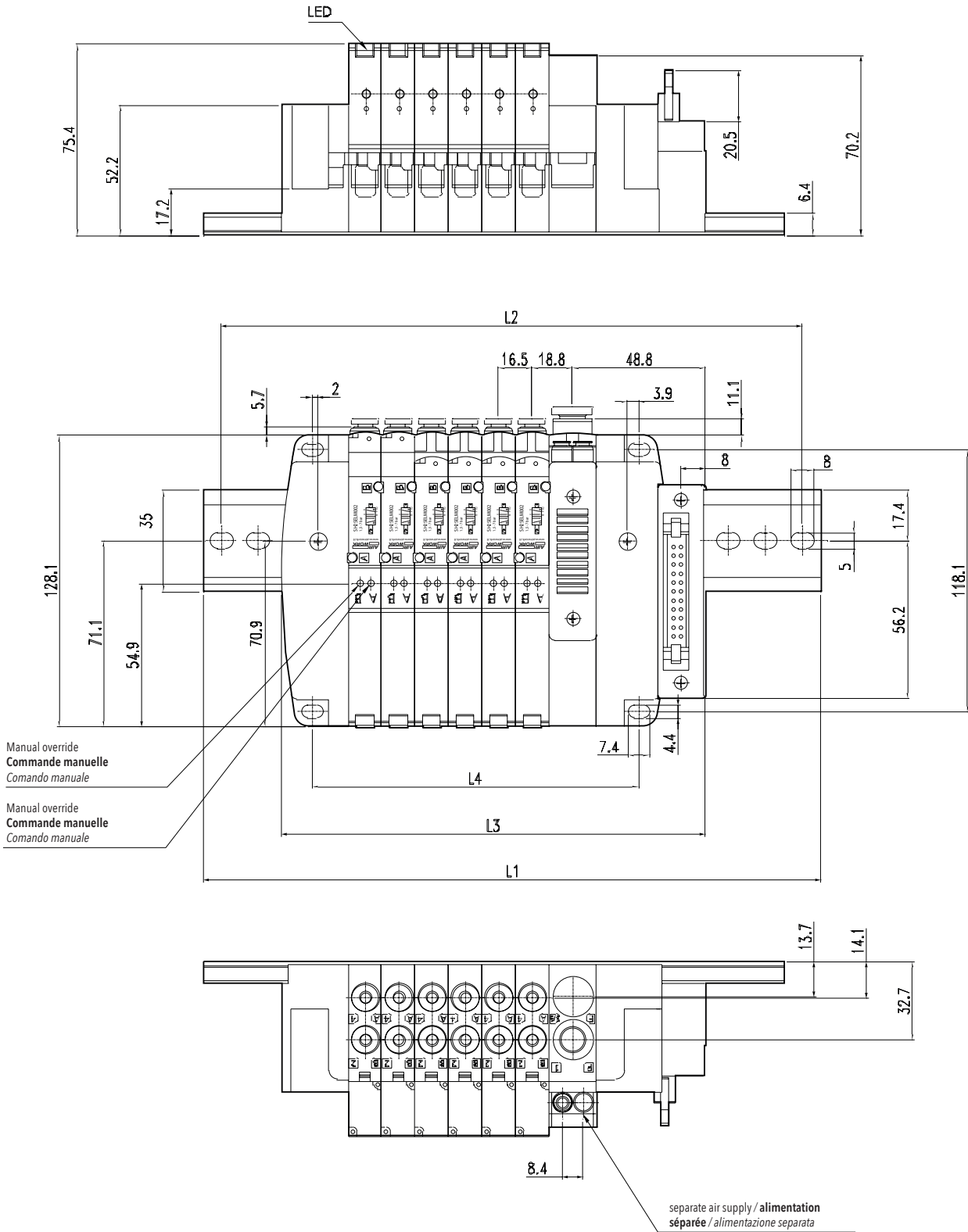

dim \ pos	2	3	4	5	6	7	8	9	10	11	12	13	14	15	16	17	18	19	20	21	22	23	24
L1			250					300				400					500					587	
L2			237.5					287.5				387.5					487.8					574.5	
L3	117.7	134.2	150.7	167.2	183.7	200.2	216.7	233.2	249.7	287.2	303.7	320.2	336.7	353.2	369.7	386.2	402.7	419.2	435.7	452.2	468.7	485.2	501.7
L4	81	97.5	114	130.5	147	163.5	180	196.5	213	250.5	267	283.5	300	316.5	333	349.5	366	382.5	399	415.5	432	448.5	465

ELECTRICAL CONNECTION SYSTEM / SYSTÈME DE CABLAGE ELECTRIQUE / SISTEMA DI CONNESSIONE ELETTRICA

For non-polarized solenoid valves, you can use any of (+) or (-) common.

Since wiring is shown for less than 12 connections, for D-SUB wiring the single is available only for Sol A, double is a sequence of 1-14 / 2-15 / etc.

Flat cable connector has to be done with sequence of 1-2 / 3-4 / etc.. without any omission. However, it should be cautious that the possibility to combine single and double solenoids is different from the wiring beside.

Pour les électrovannes non polarisées, vous pouvez utiliser n'importe lequel des fils (+) ou (-) ensemble.

Etant donné que le câblage est indiqué pour moins de 12 connexions, pour le câblage avec SUB-D, SINGLE est disponible uniquement pour Sol A, DOUBLE est une séquence de 1-14 / 2-15 / etc.

Le connecteur de câble FLAT doit être fait avec une séquence de 1-2 / 3-4 / etc.. sans aucune omission.

Cependant, il convient de veiller à ce que la possibilité de combiner des électropilotes simples et doubles soit différente du câblage ci-contre.

Per le elettrovalvole non polarizzate, è possibile utilizzare qualsiasi filo (+) o (-) comune. Poiché il cablaggio è mostrato per meno di 12 connessioni, per il cablaggio D-SUB il singolo è disponibile solo per il Sol A, per il doppio è una sequenza di 1-14 / 2-15 / ecc.

La connessione del cavo FLAT deve essere fatta con sequenza di 1-2 / 3-4 / ecc. senza alcuna omissione.

Tuttavia, dovrebbe essere tenuto in considerazione che la possibilità di combinare solenoidi singoli e doppi sia diversa dal cablaggio mostrato qui accanto.

D-SUB / D-SUB / D-SUB

FLAT / FLAT / FLAT

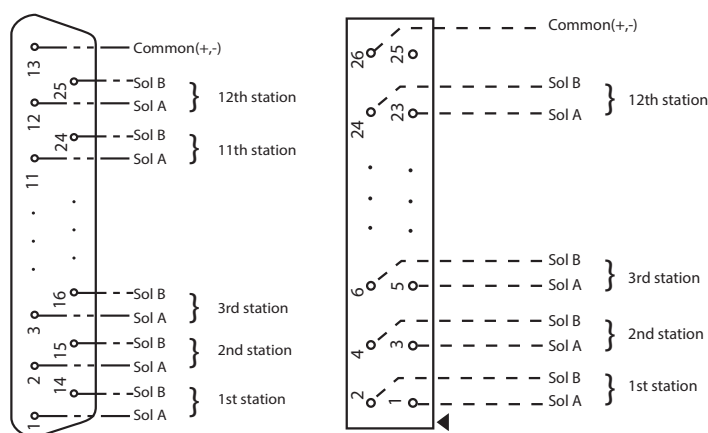

D-SUB CONNECTION SYSTEM / SYSTÈME DE CONNEXION D-SUB / SISTEMA DI CONNESSIONE PER D-SUB

N°	WIRE COLOR / COULEUR DE FIL / COLORE FILI	N°	WIRE COLOR / COULEUR DE FIL / COLORE FILI
1	Black / Noir / Nero	14	Green yellow line / Vert ligne jaune / Verde linea gialla
2	Black white line / Noir ligne blanche / Nero linea bianca	15	Green white line / Vert ligne blanche / Verde linea bianca
3	Brown / Marron / Marrone	16	Blue / Bleu / Blu
4	Brown white line / Marron ligne blanche / Marrone linea bianca	17	Blue yellow line / Bleu ligne jaune / Blu linea gialla
5	Red / Rouge / Rosso	18	Blue white line / Bleu ligne blanche / Blu linea bianca
6	Red yellow line / Rouge ligne jaune / Rosso linea gialla	19	Violet / Violet / Viola
7	Red white line / Rouge ligne blanche / Rosso linea bianca	20	Violet white line / Violet ligne blanche / Viola linea bianca
8	Pink / Rose / Rosa	21	Gray / Gris / Grigio
9	Pink white line / Rose ligne blanche / Rosa linea bianca	22	Gray red line / Gris ligne rouge / Grigio linea rossa
10	Yellow / Jaune / Giallo	23	White / Blanche / Bianco
11	Yellow red line / Jaune ligne rouge / Giallo linea rossa	24	White red line / Blanche ligne rouge / Bianco linea rossa
12	Yellow blue line / Jaune ligne bleu / Giallo linea blu	25	White blue line / Blanche ligne bleu / Bianco linea blu
13	Green / Vert / Verde		